

# **inSTRIDE<sup>®</sup>** Electronic Stepper

## Owner's Manual

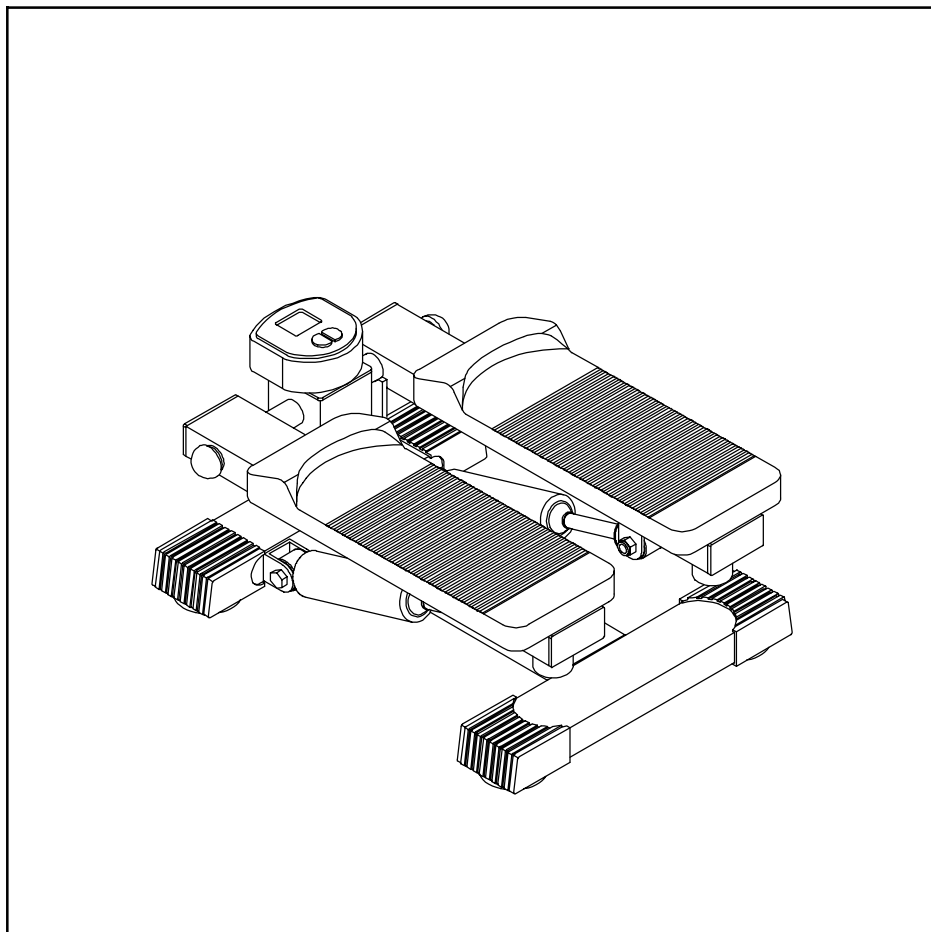

### **⚠ WARNING ⚠**

Exercise can present a health risk. Consult a physician before beginning any exercise program with this equipment. If you feel faint or dizzy, immediately discontinue use of this equipment. Serious bodily injury can occur if this equipment is not assembled and used correctly. Serious bodily injury can also occur if all instructions are not followed. Keep others and pets away from equipment when in use. Always make sure all bolts and nuts are tightened prior to each use. Follow all safety instructions in this manual.

When calling for parts or service, please specify the following number.

**40-0045A**

**STAMINA PRODUCTS**

MADE IN CHINA

Product May Vary Slightly  
From Pictured.

### **CAUTION:**

**Weight on this product should not exceed 250 lbs.**

**This Product is Produced Exclusively by**

***Stamina*<sup>®</sup>**  
**PRODUCTS, INC.**

2757 S. Austin, Springfield, MO 65807

Customer Service Number

1 (800) 375-7520

[www.staminaproducts.com](http://www.staminaproducts.com)

---

## TABLE OF CONTENTS

	Page
Safety Instructions	2
Before You Begin	4
Hardware Illustrations	5
Assembly Instructions	6
Using The Electronics Meter	7
Conditioning Guidelines	8
Warm-up and Cool-Down	9
Product Parts Drawing	10
Parts List	11
Warranty	12
Notes	13
Fax/Mail Ordering Form	14

---

### SAFETY INSTRUCTIONS

**WARNING:** To reduce the risk of serious injury, read the following Safety Instructions before using the **INSTRIDE**.

1. Shocks on steppers get **HOT** during use. To avoid burns, do not touch the shocks until they have time to cool.
2. Make sure that all nuts, bolts, screws, and knobs are tight prior to each use.
3. Always make sure that the Cable(9) is properly seated in the groove on the Pulley(8) before using the **INSTRIDE**.
4. Use the **INSTRIDE** only on a level surface.
5. Wear appropriate clothing when exercising; do not wear loose clothing that could become caught in the **INSTRIDE**.
6. Keep small children and pets away from the **INSTRIDE** at all times including while using or assembling the **INSTRIDE**.
7. The **INSTRIDE** should not be used by persons weighing more than 250 lbs.
8. The **INSTRIDE** should be used by only one person at a time.
9. Be careful to maintain your balance while using, mounting, dismounting, or assembling the **INSTRIDE**, loss of balance may result in a fall and serious bodily injury.
10. Use the **INSTRIDE** only as described in the manual.

**WARNING:** Before starting any exercise or conditioning program you should consult with your personal physician to see if you require a complete physical exam. This is especially important if you are over the age of 35, have never exercised before, are pregnant, or suffer from any illness. **READ AND FOLLOW THE SAFETY INSTRUCTIONS. FAILURE TO FOLLOW THESE INSTRUCTIONS CAN RESULT IN SERIOUS BODILY INJURY.**

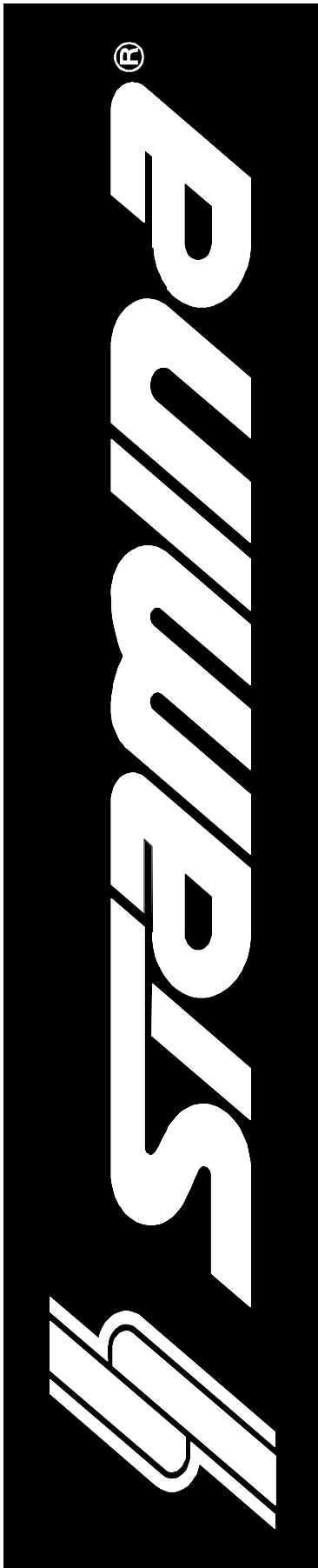

**CALL  
US FIRST  
1 (800) 375-7520**

---

**THANK YOU FOR PURCHASING THE INSTRIDE**

To help you get started, we have pre-assembled most of your **INSTRIDE** at the factory with the exception of those few parts left unassembled for shipping purposes. Simply follow the few assembly instructions set forth in this manual. Within a few minutes you will be getting your body into shape and on your way to achieving a happier and healthier lifestyle.

Should you have any questions, please call our Customer Service Department toll-free number, 1 (800) 375-7520, Monday - Friday, 8:00 A.M. - 5:00 P.M., Central Time.

## BEFORE YOU BEGIN

Thank you for choosing the **INSTRIDE**. We take great pride in producing this quality product and hope it will provide many hours of quality exercise to make you feel better, look better and enjoy life to its fullest.

Yes, it's a proven fact that a regular exercise program can improve your physical and mental health. Too often, our busy lifestyles limit our time and opportunity to exercise. The **INSTRIDE** provides a convenient and simple method to begin your assault on getting your body in shape and achieving a happier and healthier lifestyle.

Before reading further, please review the drawing below and familiarize yourself with the parts that are labeled.

Read this manual carefully before using the **INSTRIDE**.

Although Stamina tries to manufacture its products with the finest materials and uses the highest standards of manufacturing, occasionally a part that does not fit, is the incorrect size, or is otherwise inappropriate is found. Even with the highest inspection and quality controls in place these things will happen occasionally. Please do not return the product. For your convenience, Stamina has a Customer Service Department with a toll-free number. If a part is missing, does not fit, is the incorrect size, or is otherwise inappropriate, please call 1 (800) 375-7520 (in the U.S.) between 8:00 A.M. and 5:00 P.M. Central Time, Monday through Friday. Our operators will be able to assist you with your problem and the parts will be mailed directly to your house.

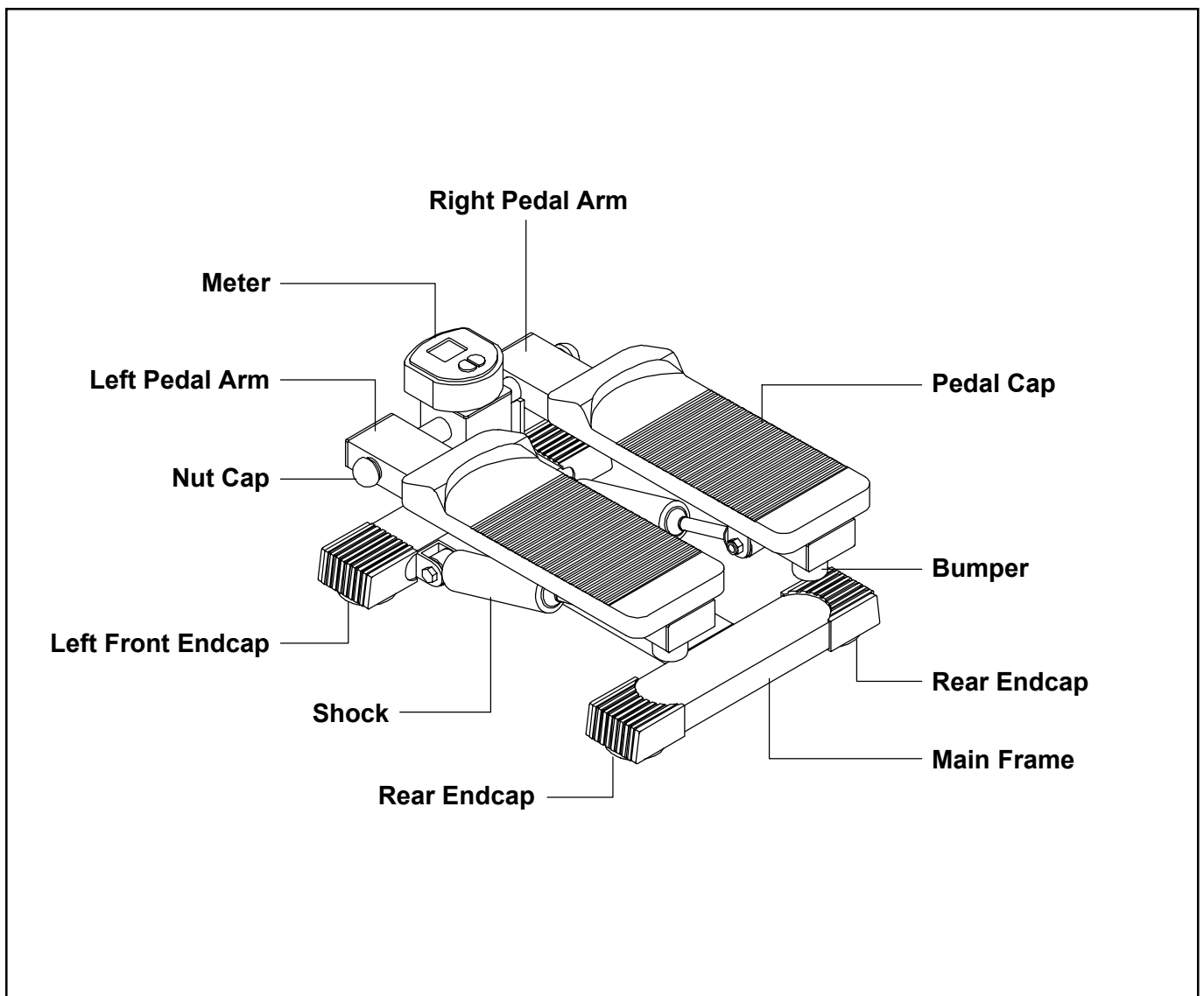

# HARDWARE ILLUSTRATIONS

This chart is provided to help identify some of the small parts used in the assembly of this product. This sheet may not include all the hardware needed to assemble your product. It is intended to be used as a guide to help simplify your assembly process.

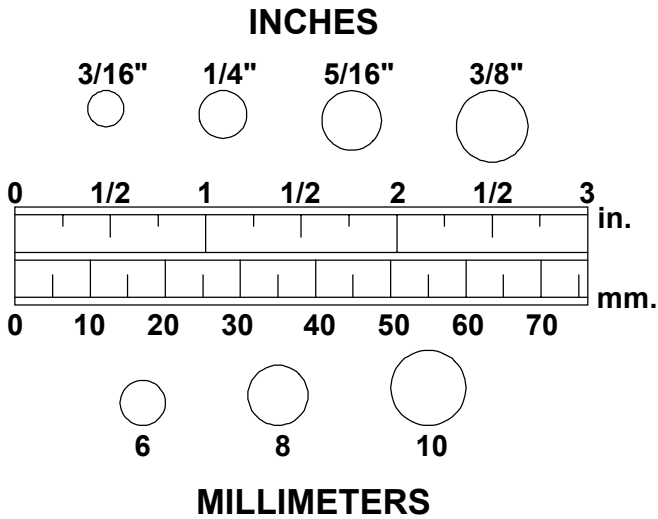

Place washers, the end of bolts or screws on the circles to check for the correct size. Use the small scale to check the sizes of bolts and screws.

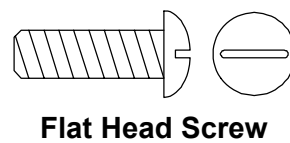
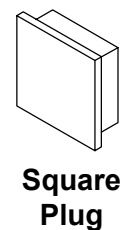
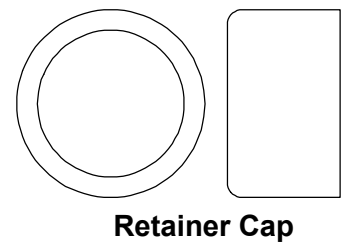
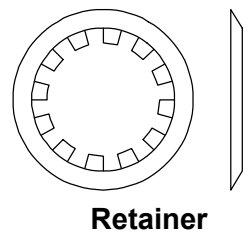
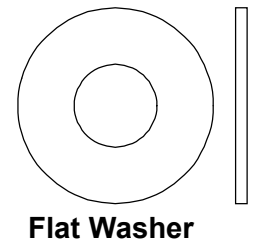
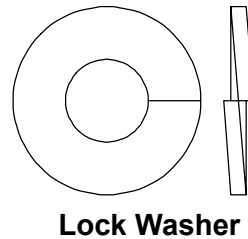
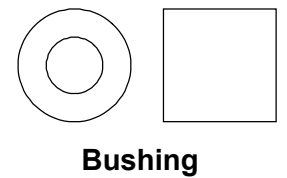
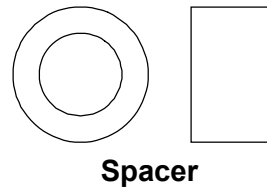
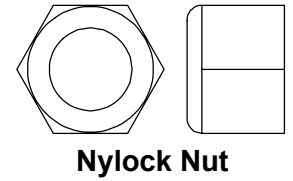
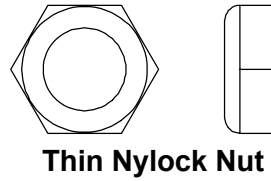
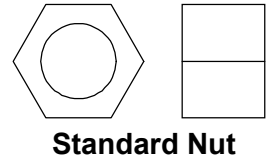
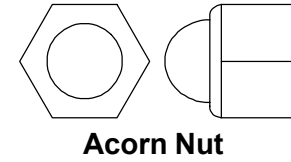
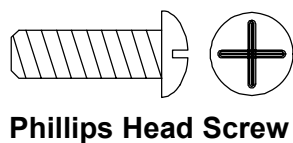
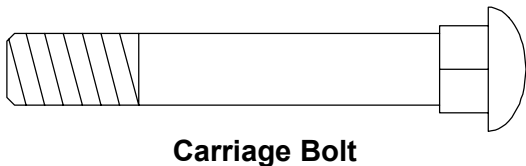
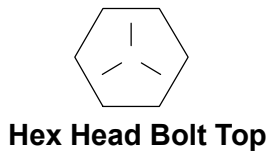
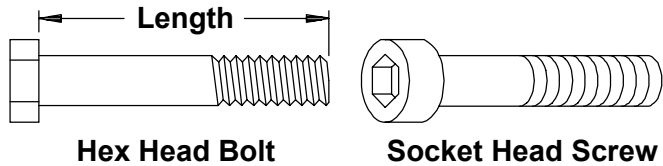

## ASSEMBLY INSTRUCTIONS

Place all parts from the box in a cleared area and position them on the floor in front of you. Remove all packing materials from your area and place them back into the box. Do not dispose of the packing materials until assembly is completed. Read each step carefully before beginning. If you are missing a part please call our toll-free number for assistance **1 (800) 375-7520** or e-mail us at:

**parts@staminaproducts.com**

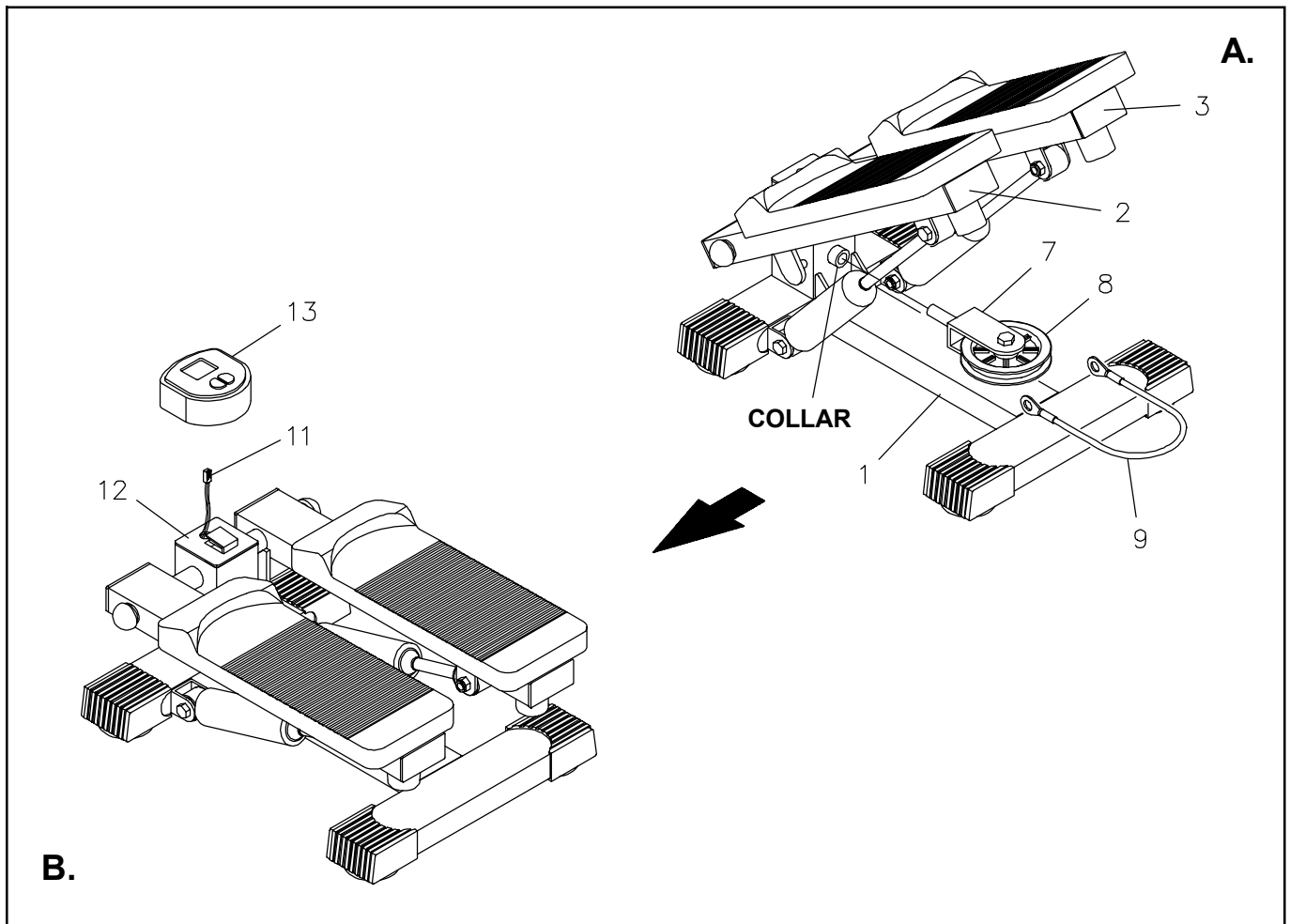

### STEP 1

Lift up the **LEFT** and **RIGHT PEDAL ARMS**(2, 3). Insert the **PULLEY BRACKET**(7) into the Collar on the **MAIN FRAME**(1). Wrap the **CABLE**(9) around the **PULLEY**(8) and press the two **PEDAL ARMS** (2, 3) down. Refer to illustration A.

**NOTE:** Always make sure that the **CABLE**(9) is properly seated in the groove on the **PULLEY**(8) before using the **INSTRIDE**.

### STEP 2

Install two "**AA**" batteries into the back of the **METER**(13). Plug the **SENSOR WIRE**(11) into the **METER**(13), then slide the **METER**(13) onto the **MOUNTING CAP**(12). Refer to illustration B.

**NOTE:** Please be careful not to damage the **SENSOR WIRE**(11) when attaching the **METER**(13).

---

## USING THE ELECTRONIC METER

**POWER ON** : Pedal movement or push any button.

**POWER OFF** : Automatic shut off after 5 minutes of inactivity.

### FUNCTION BUTTONS:

**ST/STOP** : Push to start or stop the functions.

**RESET** : To reset all functions to zero.

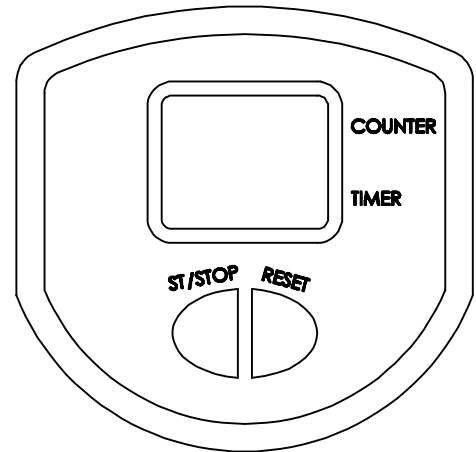

### FUNCTION:

**TIMER**: Displays the time, from 1 sec up to 99:59 minutes.

**COUNTER**: Displays the total step count, from zero to 9999 steps.

**NOTE**: 1. The meter will stop counting time automatically after 4 seconds of inactivity. All function values will be kept. Restart the meter by moving the pedals.

2. The electronic meter uses two "AA" or "UM-3" batteries.

## CONDITIONING GUIDELINES

How you begin your exercise program depends on your physical condition. If you have been inactive for several years, or are severely overweight, you must start slowly and increase your time on the **INSTRIDE** gradually: a few minutes per workout.

Initially, you may be able to exercise only for a few minutes in your target zone, however, your aerobic fitness will improve over the next six to eight weeks. Don't be discouraged if it takes longer. It's important to work at your own pace. Ultimately, you'll be able to exercise continuously for 30 minutes. The better your aerobic fitness, the harder you will have to work to stay in your target zone. Please remember these essentials:

- Have your doctor review your training and diet programs to advise you of a workout routine you should adopt.
- Begin your training program slowly with realistic goals that have been set by you and your doctor.
- Monitor your pulse frequently. Establish your target heart rate base on your age and condition.
- Set up your **INSTRIDE** on a flat, even surface at least 3 feet from walls and furniture.

## EXERCISE INTENSITY

To maximize the benefits of exercising, it is important to exercise with the proper intensity. The proper intensity level can be found by using your heart rate as a guide. For effective aerobic exercise, your heart rate should be maintained at a level between 70% and 85% of your maximum heart rate as you exercise. This is known as your target zone. You can find your target zone in the table below. Target zones are listed for both unconditioned and conditioned persons according to age.

AGE	UNCONDITIONED TARGET ZONE (BEATS/MIN.)	CONDITIONED TARGET ZONE (BEATS/MIN.)
20	138~167	133~162
25	136~166	132~160
30	135~164	130~158
35	134~162	129~156
40	132~161	127~155
45	131~159	125~153
50	129~156	124~150
55	127~155	122~149
60	126~153	121~147
65	125~151	119~145
70	123~150	118~144
75	122~147	117~142
80	120~146	115~140
85	118~144	114~139

During the first few months of your exercise program, keep your heart rate near the low end of your target zone as you exercise. After a few months, your heart rate can be increased gradually until it is near the middle of your target zone as you exercise.

To measure your heart rate, stop exercising but continue moving your legs or walking around and place two fingers on your wrist. Take a six-second heartbeat count and multiply the results by 10 to find your heart rate. For example, if your six-second heartbeat count is 14, your heart rate is 140 beats per minute. (A six-second count is used because your heart rate will drop rapidly when you stop exercising.) Adjust the intensity of your exercise until your heart rate is at the proper level.

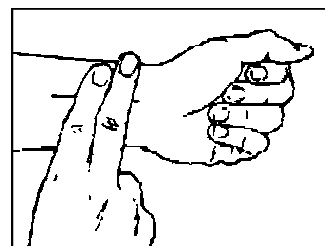

---

## WARM-UP and COOL-DOWN

**Warm-up** The purpose of warming up is to prepare your body for exercise and to minimize injuries. Warm up for two to five minutes before strength-training or aerobic exercising. Perform activities that raise your heart rate and warm the working muscles. Activities may include brisk walking, jogging, jumping jacks, jump rope, and running in place

**Stretching** Stretching while your muscles are warm after a proper warm-up and again after your strength or aerobic training session is very important. Muscles stretch more easily at these times because of their elevated temperature, which greatly reduces the risk of injury. Stretches should be held for 15 to 30 seconds. Do not bounce.

### Suggested Stretching Exercises

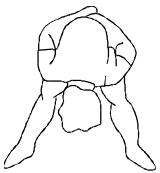

#### Lower Body Stretch

Place feet shoulder-width apart and lean forward. Keep this position for 30 seconds using the body as a natural weight to stretch the backs of the legs. **DO NOT BOUNCE!**

When the pull on the back of the legs lessens, try a lower position gradually.



#### Floor Stretch

While sitting on the floor, open the legs as wide as possible. Stretch the upper body toward the knee on the right leg by using your arms to pull your chest to your thighs. Hold this stretch 10 to 30 seconds. **DO NOT BOUNCE!** Do this stretch 10 times. Repeat the stretch with the left leg.

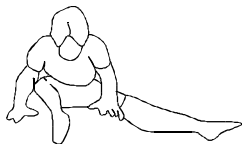

#### Bent Torso Pulls

While sitting on the floor, have legs apart one leg straight and one knee bent. Pull the chest down to touch the thigh on the leg that is bent and twist at the waist. Hold this position at least 10 seconds. Repeat 10 times on each side.

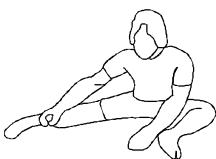

#### Bent Over Leg Stretch

Stand with feet shoulder-width apart and lean forward as illustrated. Using the arms, gently pull the upper body towards the right leg. Let the head hang down. **DO NOT BOUNCE!** Hold the position a minimum of 10 seconds. Repeat pulling the upper body to the left leg. Do this stretch several times slowly.

**Remember always to check with your physician before starting any exercise program.**

**Cool-Down** The purpose of cooling down is to return the body to its normal, or near normal, resting state at the end of each exercise session. A proper cool-down slowly lowers your heart rate and allows blood to return to the heart. Your cool-down should include the stretches listed above and should be completed after each strength-training session.



---

## PARTS LIST

DIAGRAM#	PART NAME	QTY
1	Main Frame	1
2	Left Pedal Arm	1
3	Right Pedal Arm	1
4	Pedal Cap	2
5	Bumper	2
6	Shock	2
7	Pulley Bracket	1
8	Pulley	1
9	Cable	1
10	Magnet	1
11	Sensor Wire	1
12	Mounting Cap (60 x 60mm)	1
13	Meter	1
14	Nut Cap (M8)	2
15	Left Front Endcap (30 x 60mm)	1
16	Right Front Endcap (30 x 60mm)	1
17	Rear Endcap (30 x 60mm)	2
18	Rectangular Plug (30 x 60mm)	4
19	Screw, Round Head (M3 x 10mm)	2
20	Bolt, Round Head (M6 x 1 x 38mm)	4
21	Bolt, Hex Head (M8 x 1.25 x 16mm)	2
22	Bolt, Hex Head (M8 x 1.25 x 38mm)	4
23	Bolt, Hex Head (3/8" - 16 x 1 9/16")	1
24	Nylock Nut (M8 x 1.25)	4
25	Nylock Nut (3/8" - 16)	1
26	Washer (M8)	2
27	Lock Washer (M8)	2
28	Manual	1

## WARRANTY

Stamina Products, Inc. (the "Warrantor") warrants to the original purchaser only, that this product will be free from defects in materials and workmanship under normal use, service and proper operation for a period of 90 days on the parts and 5 years on the frame from the date of the purchase by the original purchaser. **THIS WARRANTY SHALL NOT APPLY TO ANY PRODUCT WHICH HAS BEEN SUBJECT TO COMMERCIAL USE, ABUSE, MISUSE, ALTERATION OF ANY TYPE OR CAUSE OR TO ANY DEFECT OR DAMAGE CAUSED BY REPAIR, REPLACEMENT, SUBSTITUTION OR USE WITH PARTS OTHER THAN PARTS PROVIDED BY STAMINA PRODUCTS, INC.** Commercial use includes use of the product in athletic clubs, health clubs, spas, gymnasiums, exercise facilities, and other public or semipublic facilities whether or not the product's use is in furtherance of a profit making enterprise, and all other use which is not for personal, family, or household purposes.

To implement this limited warranty, send a written notice stating your name, date, and place of purchase and a brief description of the defect along with your receipt to **Stamina Products, Inc. P.O. Box 1071, Springfield Missouri, USA, 65801-1071** or call us at **1 (800) 375-7520**. If the defect is covered under this limited warranty, you will be requested to return the product or part to us for free repair or replacement at our option. **NO ACTION FOR BREACH OF THIS LIMITED WARRANTY MAY BE COMMENCED MORE THAN ONE (1) YEAR AFTER THE DATE THE ALLEGED BREACH WAS OR SHOULD HAVE BEEN DISCOVERED. NO ACTION FOR BREACH OF ANY IMPLIED WARRANTY MAY BE COMMENCED MORE THAN ONE (1) YEAR AFTER DELIVERY OF THE PRODUCT TO THE PURCHASER.** This limited warranty is not transferable. **IF ANY PART OF THE PRODUCT IS NOT IN COMPLIANCE WITH THIS LIMITED WARRANTY OR ANY IMPLIED WARRANTY, THE REMEDY OF REPAIR OR REPLACEMENT IS THE EXCLUSIVE REMEDY AVAILABLE TO YOU.** In the event that the purchaser makes any claim under this limited warranty or any implied warranty, the Warrantor reserves the right to require the product to be returned for inspection, at the purchaser's expense, to the Warrantor's premises in Springfield, Missouri. Return of the enclosed warranty registration card is not required for warranty coverage, but is merely a way of establishing the date and place of purchase.

Stamina Products, Inc. **SHALL NOT BE LIABLE FOR THE LOSS OF USE OF ANY PRODUCT, LOSS OF TIME, INCONVENIENCE, COMMERCIAL LOSS OR ANY OTHER INDIRECT, CONSEQUENTIAL, SPECIAL OR INCIDENTAL DAMAGES DUE TO BREACH OF THE ABOVE WARRANTY OR ANY IMPLIED WARRANTY.**

This limited warranty is the only written or express warranty given by Stamina Products, Inc. This warranty gives you specific legal rights, and you may also have other legal rights which vary from state to state. **ANY OTHER RIGHT WHICH YOU MAY HAVE, INCLUDING ANY IMPLIED WARRANTY OR MERCHANTABILITY OR FITNESS FOR A PARTICULAR PURPOSE, IS LIMITED IN DURATION TO THE DURATION OF THIS WARRANTY.**

The laws in some jurisdictions restrict the rights of manufacturers and distributors of consumer goods to disclaim or limit implied warranties and consequential and incidental damages with respect thereto. If any such law is found to be applicable, the foregoing disclaimers and limitations of and on implied warranties and consequential and incidental damages with respect thereto shall be disregarded and shall be deemed not to have been made to the extent necessary to comply with such legal restriction.

---

## NOTES

